



**FACADE SYSTEM
MAX-3**

VOX

FREEDOM BEGINS AT HOME 4

MAX-3

DESIGNED FOR

EXTREME CONDITIONS 6

THINKING ABOUT NATURE 8

EXCEPTIONAL DURABILITY IN

EXTREME CONDITIONS 10

MAX-3 TECHNOLOGY 12

MAX-3 SYSTEM COLOURS 14

PANELS AND FINISHING PROFILES 20

PRODUCT FEATURES 21

INSTALLATION VARIANTS 22





FREEDOM BEGINS

AT HOME

VOX is an innovative European brand in the interior design and home finishing industry and is a key brand of the VOX Capital Group.

At VOX, we believe that true freedom begins at home and the place we live in makes a huge impact on our lives. That is why our goal is to continuously develop and deliver comprehensive solutions – from matching collections of wall systems, furniture, doors and floors, to the highest quality facade cladding and ceilings.

In 2018, the VOX brand ventured into the Indian Market as VOX Building Products Pvt Ltd.

VOX's presence in India spans over 250 cities with a strong network of distributors, dealers, and installers. The factory in India started the production in 2023.





DESIGNED FOR EXTREME CONDITIONS

The MAX-3 system is the result of the search for the ideal facade system, which is endowed with the advantages of both vinyl and metal siding and at the same time eliminates their disadvantages. Thanks to the use of our innovative, three-layer technology the MAX-3 panels have high resistance to mechanical damage, previously available only for metal siding and high resistance to low and high temperatures.

At the same time, unlike metal coverings, MAX-3 cladding is much easier to process and install, and during use it does not corrode, also retains its color longer.

The facade does not require specialist maintenance and painting.

The elegant and simple design of the flat panel guarantees an exceptionally attractive facade. The panel can be installed both horizontally and vertically.

HONEY OAK, FLAT PANEL

THINKING ABOUT NATURE

Taking care of the environment is our common duty – both on an individual and business level.

When creating the VOX offer, we analyze the production opportunities on an ongoing basis, and we make every effort to ensure that the carbon footprint that we leave in the ecosystem is as low as possible. Modern technological lines, the use of high-quality raw materials, recipes improved over the years and well thought-out design of the products themselves allow to maintain their excellent technical parameters and functionality.

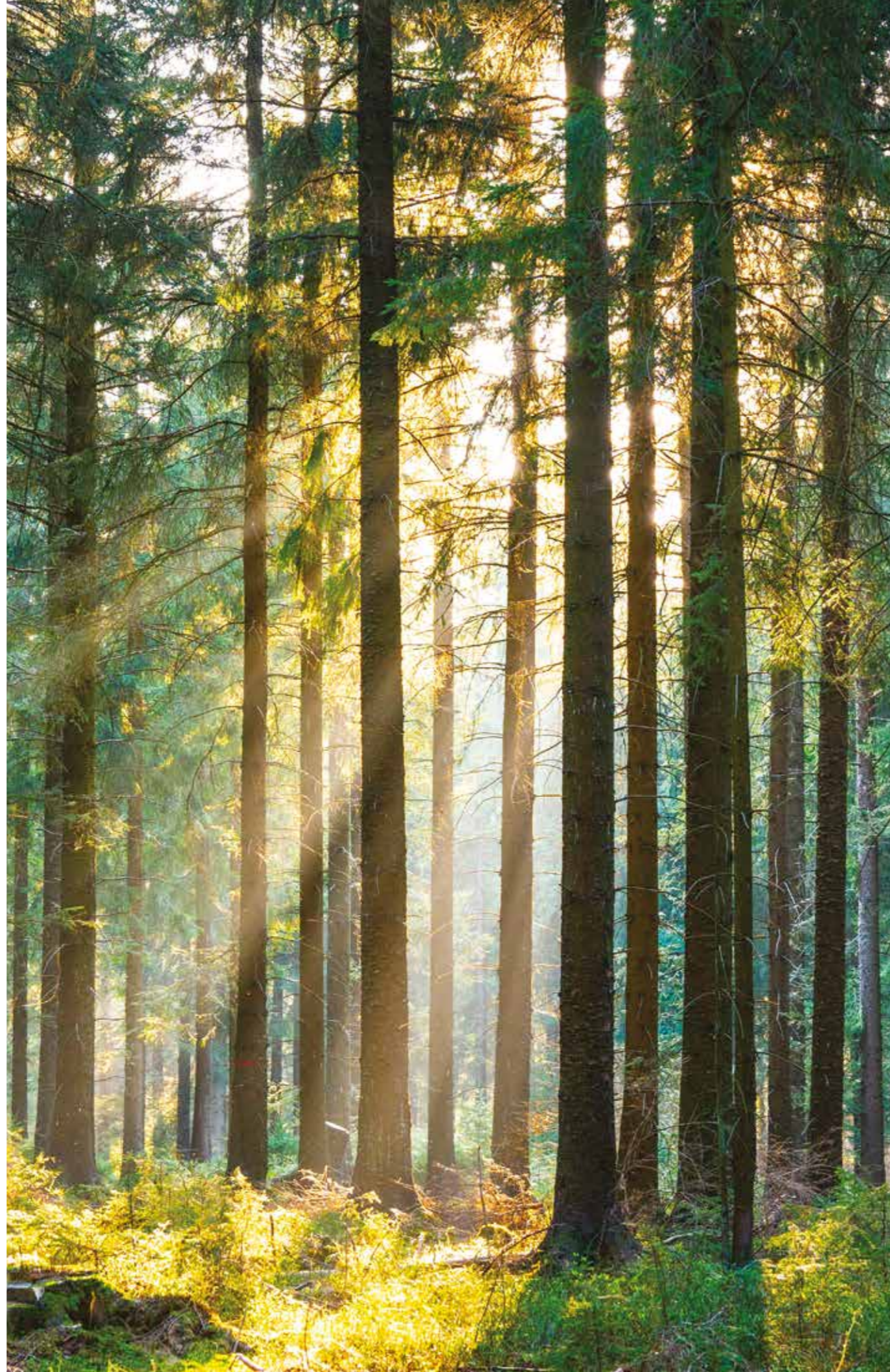

RECYCLING

We use recycled materials in production. Depending on the product, the weight of recyclable materials is up to 80% of the total.



DURABILITY

Our products are extremely durable. The lifetime of many is 10 or even 50 years.



MAINTENANCE

There is no need for maintenance over the entire lifetime, and therefore no additional chemicals (paints, preservatives, etc.)

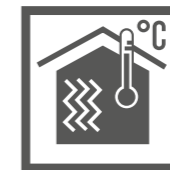

INSULATION

Claddings ensure proper ventilation of the facade and protect it against moisture.



HEALTH

Our products are safe for health. They do not contain harmful substances and do not release volatile organic compounds.



CARBON FOOTPRINT

Reduces the carbon footprint of up to 40% compared to products made only of synthetic polymers.



OAK WINCHESTER, FLAT PANEL

MAX-3. EXCEPTIONAL DURABILITY IN EXTREME CONDITIONS

INNOVATIVE TECHNOLOGY

The three-layer technology used in the production of Max-3 causes the panels to combine high mechanical resistance with the capabilities of the polymer material in terms of shape, color and structure.

RESISTANCE TO EXTREME TEMPERATURES

The panels are designed with reduced linear expansion, which ensures their high resistance to both low and very high temperatures.

METAL DURABILITY

The base layer of the panel is its core, which gives it the metal's test-proven durability. Importantly, the panels Max-3 are non-corrosive and easy to work with.

FIRST LAYER

guarantees shape stability and helps when carrying out installation, regardless of the ambient air temperature.

SECOND LAYER

provides the panels with increased resistance to mechanical damage.

THIRD LAYER

responsible for UV resistance; wood texture; structure to limit contamination of the panel, thereby guaranteeing an excellent appearance of the facade for many years.





Scan the QR Code and see the video of the full test, carried out on sample panels available on the market.

MAX-3 TECHNOLOGY

The MAX-3 system panels are manufactured using the MAX-3 Triple Extrusion Technology. They are characterised by incredible resistance to mechanical damage, which was previously possible only with metal siding, as well as a low coefficient of linear expansion, which provides high resistance to low and high temperatures.

At the same time, unlike metal coatings, the MAX-3 system is convenient and easy to install, and does not corrode during use, does not peel, does not tarnish, and does not require special care.



SIDING TEST RESULTS AT A FORCE OF 13.5 J



PANELS MADE USING
MAX-3 TECHNOLOGY



VINYL SIDING
BRAND A

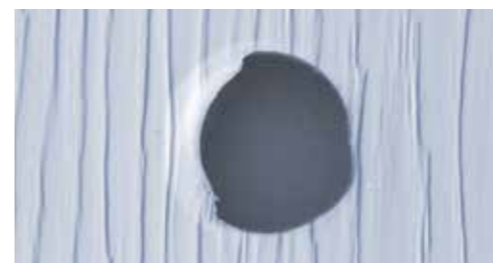

VINYL SIDING
BRAND B



METAL SIDING
BRAND C





MAX-3 SYSTEM COLOURS

The MAX-3 system helps to create an aesthetically pleasing facade. Panels are made using thermal printing technology. Thanks to this technique, our panels look like natural wood and are highly resistant to scratches and sunlight.

The latest colours, Winchester Oak and Honey Oak, were made using Thermoprint 2, an upgraded thermal printing technology. Because of that, the wood pattern on the siding is even more diverse and interesting, without a repetitive effect.



COLOURS



ASH
SXP 05



BEECH
SXP 05



OAK
SXP 05



GOLDEN OAK
SXP 05



OAK WINCHESTER, FLAT PANEL



OAK WINCHESTER, FLAT PANEL

COLOURS



HONEY OAK
SXP 05



OAK WINCHESTER
SXP 05

PANELS AND FINISHING PROFILES

SXP 05

Flat panel



SV 11

Starter trim

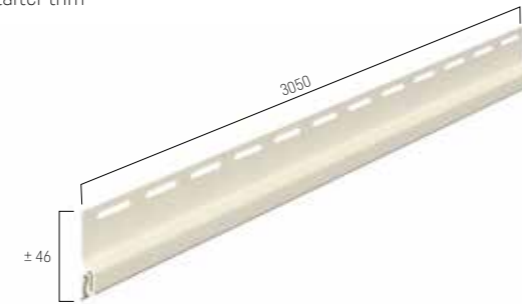

SV 11.5

Bottom ventilation trim

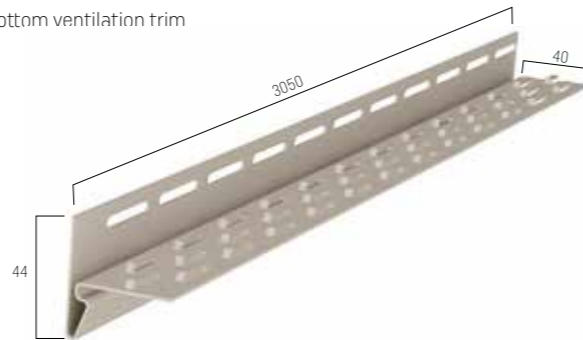

SVP 12

Outside corner



SVP 13

Inside corner

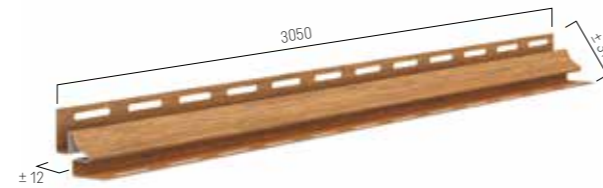

SVP 15

Connector

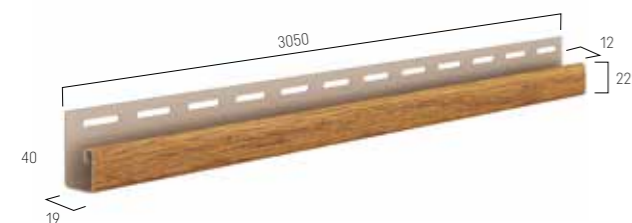













SVP 18

Joint trim



PRODUCT FEATURES

FEATURE	NORM	TEST RESULT	UNIT
 Low weight Facilitates transport and mounting		SXP(U)-05 - 2,33	kg/m ²
 Water resistance			
 Resistance to changing weather conditions			
 Impact resistance	PN-EN 13245-2:2009/AC:2010	Not less than 3J (-20,03°C), 3J (23,03°C)	J
 Incombustibility It does not burn, it melts	PN-EN 13245-2:2009/AC:2010	D-s3;d0	class
 Lead and tin free	Art. 33 of Regulation (EC) no. 1907/2006 (REACH)		
 Resistance to UV rays Colour resistance	PN-EN 20105-A02:1996 PN-EN 13245-2:2009/AC:2010		
 Quick installation Wide covering width, built-in locks and factory made nail slots facilitate and speed up the installation			
 Click System Thanks to it, the assembly is easy and fast			
 Maintenance free No need for painting and other treatment			
 Easy to keep clean Can be clean with water and mild detergents			
 10 years product guarantee			

INSTALLATION VARIANTS

VERTICAL INSTALLATION

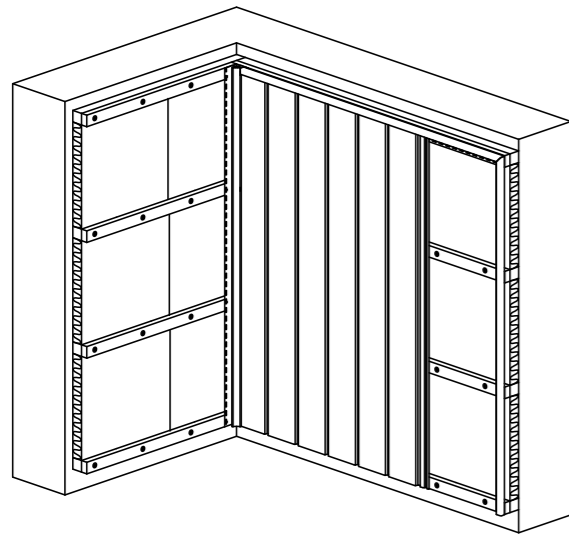

HORIZONTAL INSTALLATION

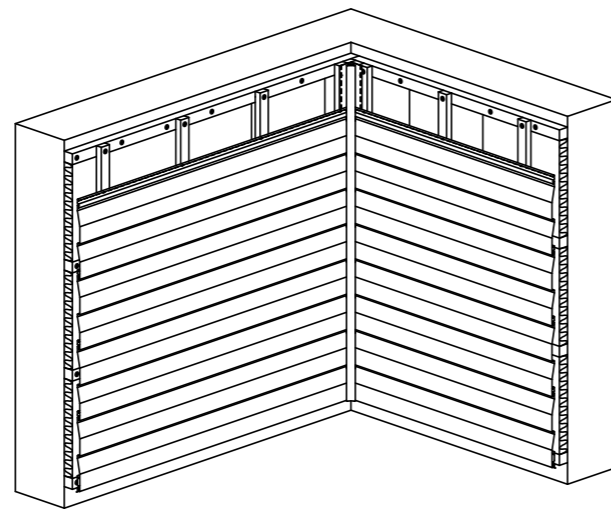

Panel SXP 05 may be installed both in a horizontal and vertical position.

Visit vox.pl or use
QR code to see
detailed installation
instructions.



The manufacturer reserves the right to change the colours, dimensions, and functions of the presented products. This catalogue is published for informational purposes only. The catalogue presents examples of patterns from the offer. Some items presented in the arrangement, photos are for decoration only and are not for sale. Copying and distribution of any materials contained in the catalogue without the written consent of the publisher is prohibited. The colours in the catalogue may differ from reality. All data contained in the catalogue are valid in the month when the catalogue is submitted for printing – January 2024.



VOX BUILDING PRODUCTS PRIVATE LIMITED

6th Floor, Leela Collonnade, The Leela Palace, No. 23, HAL Old Airport Rd,
HAL 2nd Stage, Kodihalli, Bengaluru - 560008, India
Ph No: +91 9528500500 / +91 8043741810, WA No: 6366843663
E: customercare@voxindia.co

